

# hk 40 L

## HİDROMOTOR DÖNDÜRÜCÜLÜ HİDROLİK MOBİL VİNÇ HYDRAULIC MOBILE CRANE WITH HYDROMOTOR SLEWING

Model	Kg.	8900	5600	4050	3060	2340	1820			
hk 40 L3	mt.	4.07	6.13	8.03	10.03	12.23	14.53			
hk 40 L4	Kg.	8870	5480	3970	3000	2310	1800	1400		
	mt.	4.07	6.21	8.11	10.11	12.21	14.51	16.91		
hk 40 L5	Kg.	8800	5300	3840	2880	2220	1730	1330	1030	
	mt.	4.07	6.31	8.21	10.21	12.31	14.51	16.91	19.41	
hk 40 L6	Kg.	8720	5130	3700	2770	2110	1630	1250	950	710
	mt.	4.07	6.41	8.31	10.31	12.41	14.61	16.91	19.41	22.01

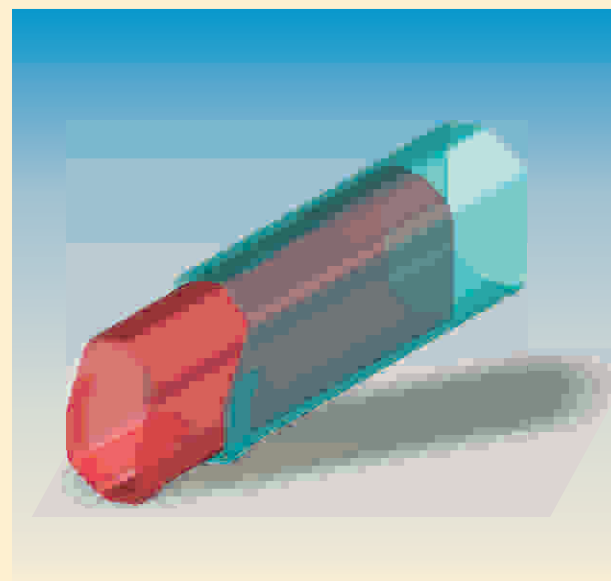

Teknik bilgiler yol gösterici olup, bağlayıcı değildir. Ölçüleri, özellikleri değiştirme ve geliştirme hakkımız saklıdır.  
Technical specialty is guider but not connective. Our changing right about size and feature is secret.

	hk 40 L3	hk 40 L4	hk 40 L5	hk 40 L6
Max. Kaldırma Momenti - Max. Lifting Moment (Tm)	40	40	40	40
Max. Kaldırma Kapasitesi (3m. radüste) - Max. Lifting Capacity (at 3m. radius) (Ton)	13.3	13.3	13.3	13.3
Hidrolik Bom Sayısı - Number of Hydraulic Boom (Adet)	3	4	5	6
Max. Hidrolik Uzanma Mesafesi - Max. Hydraulic Reach (m)	10.03	12.21	14.51	16.91
Max. Mekanik Uzanma Mesafesi - Max. Manuel Reach (m)	14.53	16.91	19.41	22.01
Max. Dönüş Açısı - Max. Slewing Angle (°)	Sür.(Cont.)	Sür.(Cont.)	Sür.(Cont.)	Sür.(Cont.)
Vinç Şasi Yüksekliği - Crane Chassis Height (mm)	150	150	150	150
Max. Çalışma Basıncı - Max. Working Pressure (Bar)	250	250	250	250
Yağ Tankı Kapasitesi - Oil Tank Capacity (lt)	150	158	166	170
Max. Çalışma Açısı- Max. Working Angle (°)	85	85	85	85
A (mm)	4335	4415	4495	4575

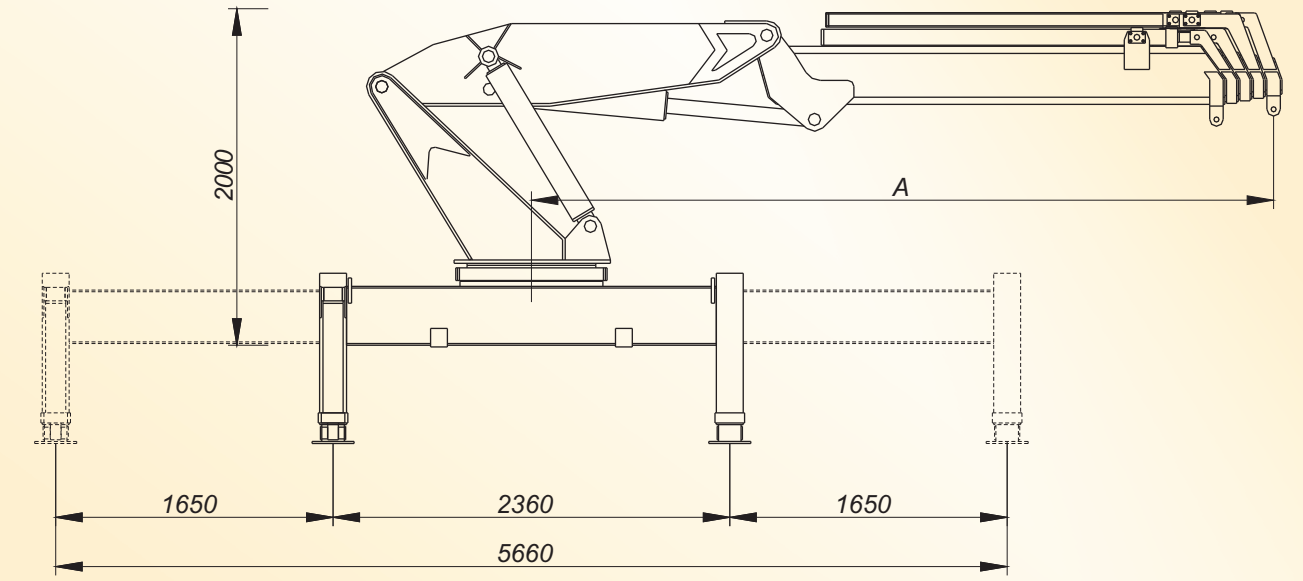

STANDART



Dönüş Açısı  
Slewing Angle



Koltuk  
Seat



Hidrolik Yağ Tankı  
Oil Tank

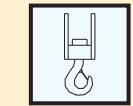

Kanca  
Hook

STANDART

OPSİYONEL

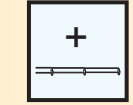

İlave Mekanik Bom  
Mechanic Extensions



İnsan Sepeti  
Basket

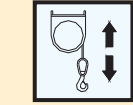

Halat Tamburu  
Winch



Uzaktan Kumanda  
Remote Control

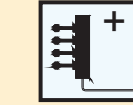

İlave Kumanda Dilimi  
Additional Function

OPSİYONEL

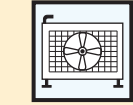

Yağ Soğutucusu  
Oil Cooler

Teknik bilgiler yol gösterici olup, bağlayıcı değildir. Ölçüleri, özellikleri değiştirme ve geliştirme hakkımız saklıdır.  
Technical specialty is guider but not connective. Our changing right about size and feature is secret.

HİDROKON KONYA HİDROLİK MAKİNA SANAYİ ve TİCARET LTD. ŞTİ.  
Büyükkayacık Mah. Evrenköy Cad. 3. O.S.B. No.13 KONYA / TÜRKİYE  
Tel : +90.332. 444 88 11 (Pbx) Fax : +90.332. 239 20 81  
E-mail : info@hidrokon.com  
www.hidrokon.com

